

Cromemco[®]

64KZ-II

Manual Addendum

**CROMEMCO, Inc.
280 Bernardo Avenue
Mountain View, CA. 94043**

Part No. 023-2017

June 1982

**Copyright © 1982
CROMEMCO, Inc.
All Rights Reserved**

This manual was produced using a Cromemco System Three computer with a Cromemco HDD-22 Hard Disk Storage System running under the Cromemco Cromix™ Operating System. The text was edited with the Cromemco Cromix Screen Editor. The edited text was proofread by the Cromemco SpellMaster™ Program and formatted by the Cromemco Word Processing System Formatter II. Camera-ready copy was printed on a Cromemco 3355A printer.

CROMEMCO 64KZ-II MANUAL ADDENDUM

Manual Changed: Cromemco 64KZ Random Access Memory
Instruction Manual
Part Number: 023-0008
Manual Date: May 1981

Make the changes shown below.

MANUAL CHANGES

Page 1, text:

Change: **Z80 and 8080 CPU compatibility**
To: **Z-80A CPU compatibility**

Delete: Powerful DMA Configuration options with DMA
OVERRIDE.

Page 1, Technical Specifications table:

Change: **+8 VOLTS @ 1.8 A (MAXIMUM)**
To: **+8 VOLTS @ 0.9 AMPERES (MAXIMUM)**

Page 3, Figure 1:

Delete the last item in the last sentence of the second
paragraph as follows

**; and a 64KZ used in a Direct Memory Access DAZZLER
system.**

Replace Figure 1 with the following figure.

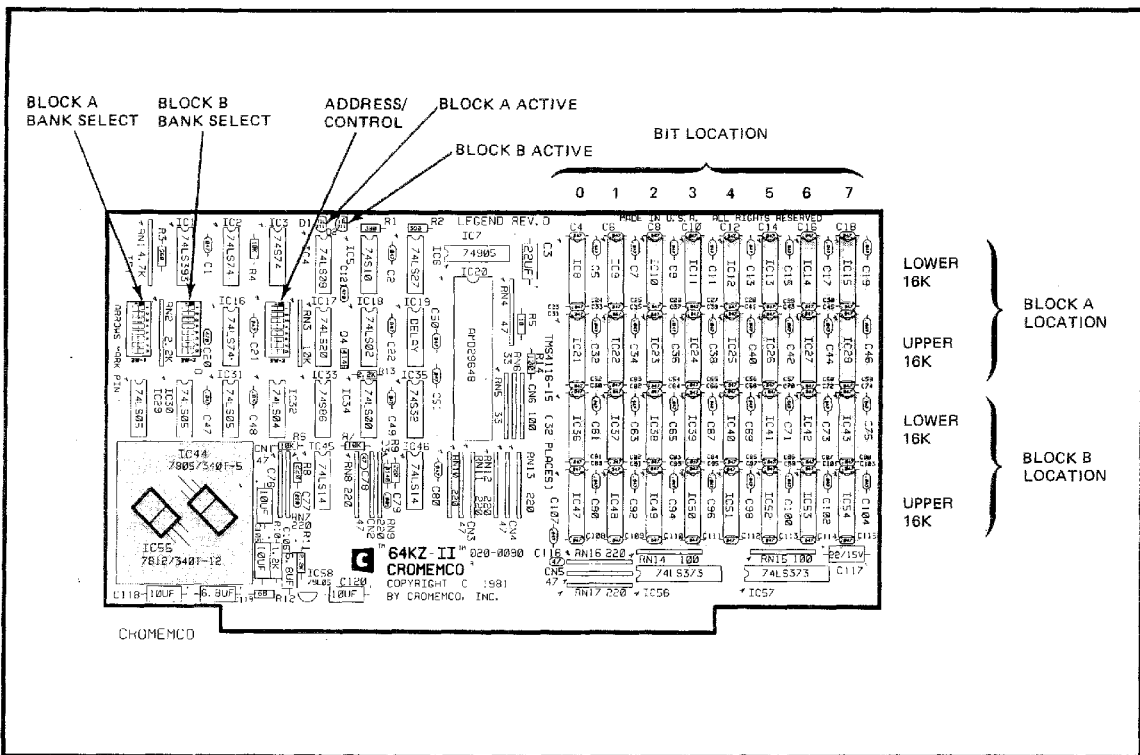

Figure A: 64KZ SWITCH, BLOCK INDICATOR, AND MEMORY CHIP LOCATIONS

Page 4, text:

Change the sentence between the figures to:

In the SW3 ADDR/CONTROL group, there are four switch functions for each memory block. These are 1) Upper 16K Array Disable, 2) Lower 16K Array Disable, 3) Reset, and 4) A15 Block Enable. Refer to Figure B.

Page 4, Figure 3:

Replace Figure 3 with the following figure.

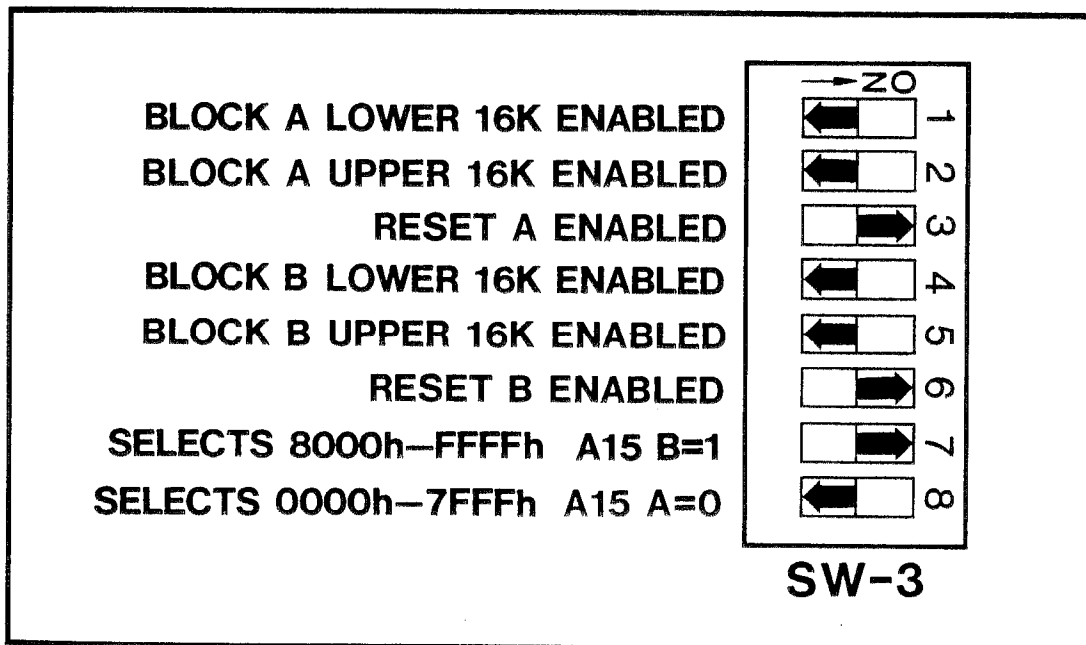

Figure B: ADDRESS/CONTROL SWITCH

Page 5, text:

Replace the three paragraphs entitled **The Override and DMA Switches** with the following:

The 16K Array Disable Switches

The 16K Array Disable Switches allow each 16Kbyte array to be disabled or enabled manually. Once the array has been manually disabled, it cannot be software enabled. Refer to Figure B.

Change **SW2** to **SW1**; **SW3** to **SW2**.

Page 6, Figure 4:

Change **SW2** to **SW1**; change **SW3** to **SW2**.

Page 6, Example 1:

Change the first sentence in the first paragraph as follows:

This example illustrates how one might configure the 64KZ-II board in a no options mode. This assumes no multiple memory banks.

Change the last sentence in the first paragraph to:

The board automatically enables after a RESET or POC since RESET A = RESET B = IN. The board remains in the memory map for all software generated BANK SELECT control words (except 0) since BANK 0-7 = IN for both BLOCK A and B.

Pages 7 and 8, Figures 5 and 6:

Change the switch positions, labeling and settings for the 64KZ-II board figures as shown in Figures A and B in this addendum.

Change **SW1** to **SW3**, **SW2** to **SW1**, and **SW3** to **SW2**.

Pages 9 through 12, text and figures:

Delete Example 3. Note that Section 2.2, at the bottom of page 12, is not deleted.

Page 13, text and figures:

Change the first sentence to the following:

There are two events which may change the active/inactive status of a 64KZ memory BLOCK:

Power On Clear (POC) or RESET and executing an OUT 40h, A instruction which configures or reconfigures the memory banks.

Delete the remainder of the page.

Page 14, text:

Delete the first two sentences.

Pages 16, 17, 18, and 21, Figures 12 through 15:

Change the switch labeling as shown in Figures A and B in this addendum.

Change SW1 to SW3, SW2 to SW1, and SW3 to SW2.

Page 22, text:

Change the first paragraph to read:

The BANK SELECT port address is changed from its factory wired 40h value by cutting the traces used to jumper across location IC7 (as shown in Figure 1). Then, a properly programmed 74S288 PROM is installed in their place. With the PROM inserted, the 64KZ-II responds to 1 of 15 remaining addresses, 41h through 4Fh. When ordering a PROM, the desired I/O address must be stated.

Delete the second paragraph.

Page 23, text:

Delete everything after the numbered items near the top of the page.

Page 24, figure and text:

Delete everything from the beginning of the page down to and including the third paragraph.

Page 25-27, Sections 2.5 and 2.6, Figures 18 and 19.

Delete all.

Page 28:

Add the following examples of switch settings for High Resolution Color Graphics Systems. Set the switches of additional 64KZ-II boards as shown in the Cromix Operating System manual for Banks 1, 2, and 3. Note that SW-3 must be set like SW-1, SW-1 like SW-2, and SW-2 like SW-3.

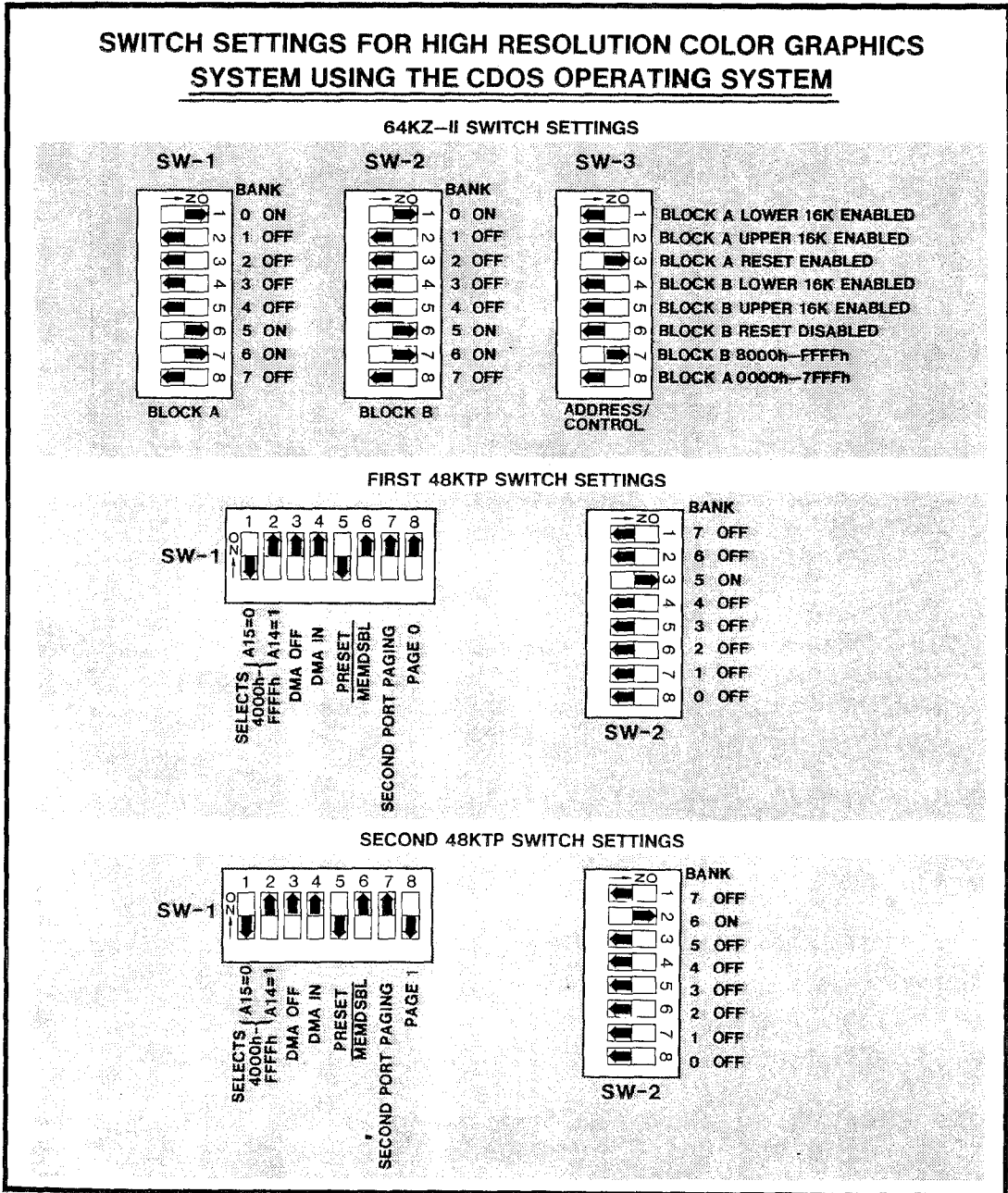
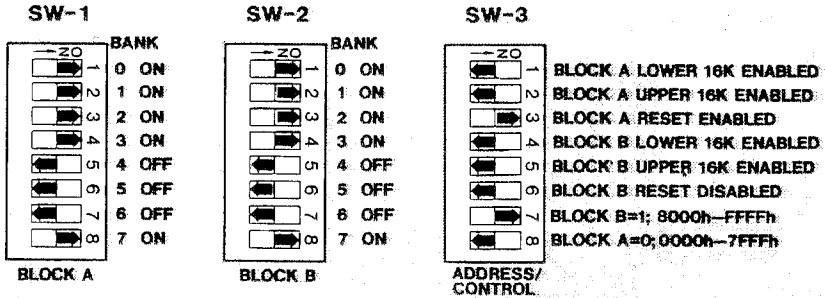

Figure C: CDOS/COLOR GRAPHICS SYSTEM SWITCH SETTINGS

SWITCH SETTINGS FOR HIGH RESOLUTION COLOR GRAPHICS SYSTEM USING THE CROMIX OPERATING SYSTEM

BANK 0 (CROMIX) 64KZ-II SWITCH SETTINGS



BANK 4 (USR 1) 64KZ-II SWITCH SETTINGS

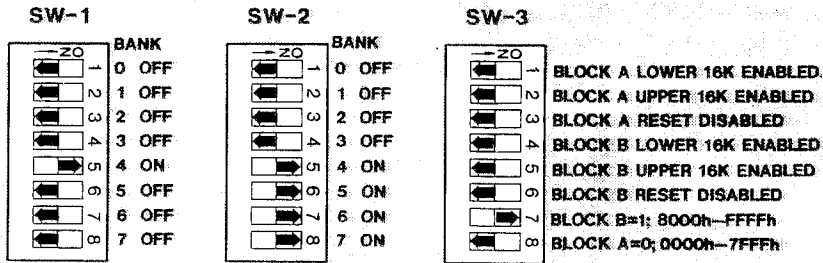

FIRST 48KTP SWITCH SETTINGS

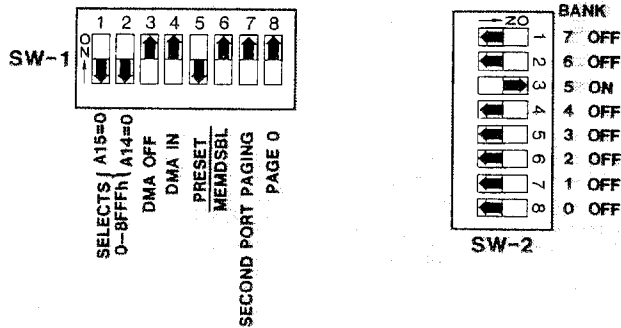

SECOND 48KTP SWITCH SETTINGS

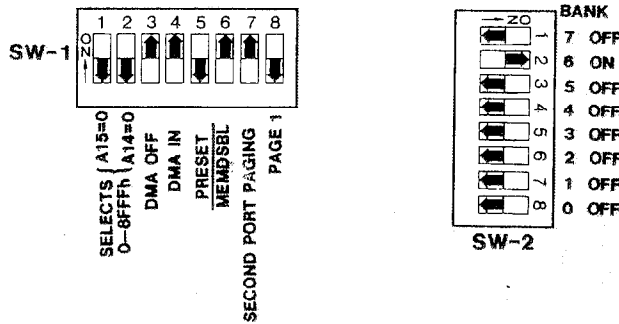

Figure D: CROMIX/COLOR GRAPHICS SYSTEM SWITCH SETTINGS

Page 29, Figure 20:

Replace Figure 20 with the following figure:

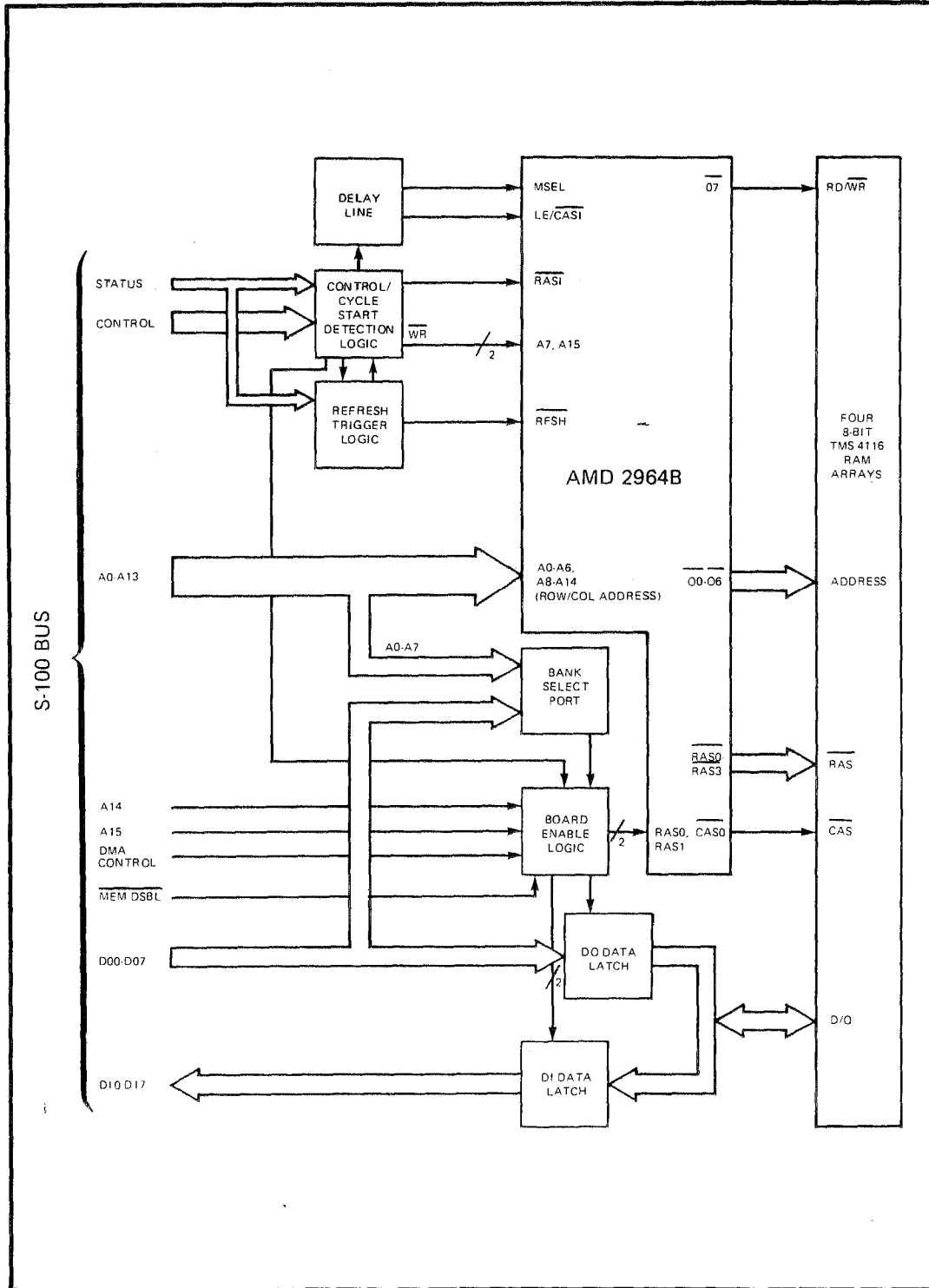

Figure E: 64KZ-II BLOCK DIAGRAM

Page 30, text:

Add the following description of the 64KZ-II board at the beginning of the page.

64KZ-II Memory Board

The 64KZ-II is a direct replacement for the 64KZ board. The difference between the boards is the way in which the functions are implemented by the hardware circuits. DMA manipulation is no longer used. Memory disable, along with the ability to disable each 16K memory array manually, is included. As shown on the new block diagram, Figure C, the timing shift registers, refresh counter, address latches, and RAS/CAS logic functions are combined into one LSI microcircuit. This reduces the power consumption while increasing the reliability of the board. All memory data passes through the data bus internal to the 64KZ-II board. Incoming data from the system DO bus is latched and held on the internal data bus. Then the incoming data is stored at the addressed memory location. Outgoing data from an addressed memory location is placed on the internal data bus. Then the outgoing data is latched onto the system DI data bus.

Page 35 and 36, Parts List:

Replace the parts list with the new parts list that follows.

PARTS LIST

Designation	Description	Cromemco Part No.
Integrated Circuits		
IC1	74LS393	010-0141
IC2	74LS74	010-0055
IC3	74S74	010-0142
IC4	74LS08	010-0064
IC5	74S10	010-0035
IC6	74LS27	010-0112
IC8-15	TMS 4116	011-0019
IC16	74LS74	010-0055
IC17	74LS20	010-0095
IC18	74LS02	010-0068
IC19	delay line	011-0080
IC20	AM2964B	010-0329
IC21-28	TMS 4116	011-0019
IC29-31	74LS05	010-0065
IC32	(non TI) 74LS04	010-0066
IC33	74S86	010-0125
IC34	74LS00	010-0069
IC35	74S32	010-0090
IC36-43	TMS 4116	011-0019
IC44	7805/340T-5	012-0001
IC45-46	74LS14	010-0061
IC47-54	TMS 4116	011-0019
IC55	7812/340T-12	012-0002
IC56-57	74LS373	010-0102
IC58	79L05	012-0053
Diodes		
D1-2	LED grn min til211	008-0020
D3-4	1N914/1N4148	008-0002

Designation	Description	Cromemco Part No.
Capacitors		
C1-2	.047 uf axial	004-0061
C3	22 uf tant	004-0028
C4-19	.047 uf axial	004-0061
C20	470 pf mono	004-0080
C21-75	.047 uf axial	004-0061
C76	10 uf tant	004-0032
C77	220 pf mono	004-0077
C78	47 pf mono	004-0000
C79	.001 uf mono	004-0043
C80-104	.047 uf axial	004-0061
C105	10 uf tant	004-0032
C106	6.8 uf tant	004-0034
C107-115	.047 uf axial	004-0061
C116	47 pf mono	004-0000
C117	22 uf tant	004-0028
C118	10 uf tant	004-0032
C119	6.8 uf tant	004-0034
C120	10 uf tant	004-0032
C121	470 pf mono	004-0080
Capacitor Networks		
CN1-5	47 pf, 8 pin	005-0000
CN6	100 pf, 8 pin	005-0001
Resistors		
R1-2	390	001-0013
R3	560	001-0015
R4	10 K	001-0182
R5	10	001-0000
R6-7	10 K	001-0182
R8-9	220	001-0010
R10	1/2 watt 1.2 K	001-0189
R11	2.2 K	001-0021
R12	68	001-0005
R13	2.2 K	001-0021

Designation	Description	Cromemco Part No.
Resistor Networks		
RN1	4.7 K, 8 pin	003-0009
RN2	2.2 K, 8 pin	003-0008
RN3	10 K, 8 pin	003-0025
RN4	47, 8 pin	003-0047
RN5-6	33, 8 pin	003-0000
RN7-13	220, 8 pin	003-0057
RN14-15	100, 8 pin	003-0001
RN16-17	220, 8 pin	003-0057
Miscellaneous		
	3 8 pos. dip switches	013-0002
	4 6-32 hex nuts	015-0013
	4 #6 lock washers	015-0020
	4 6-32x1/2 screws	015-0044
	1 large heat sink	021-0017

Page 37, 64KZ Part Location Diagram:

Replace the diagram with the following figure.

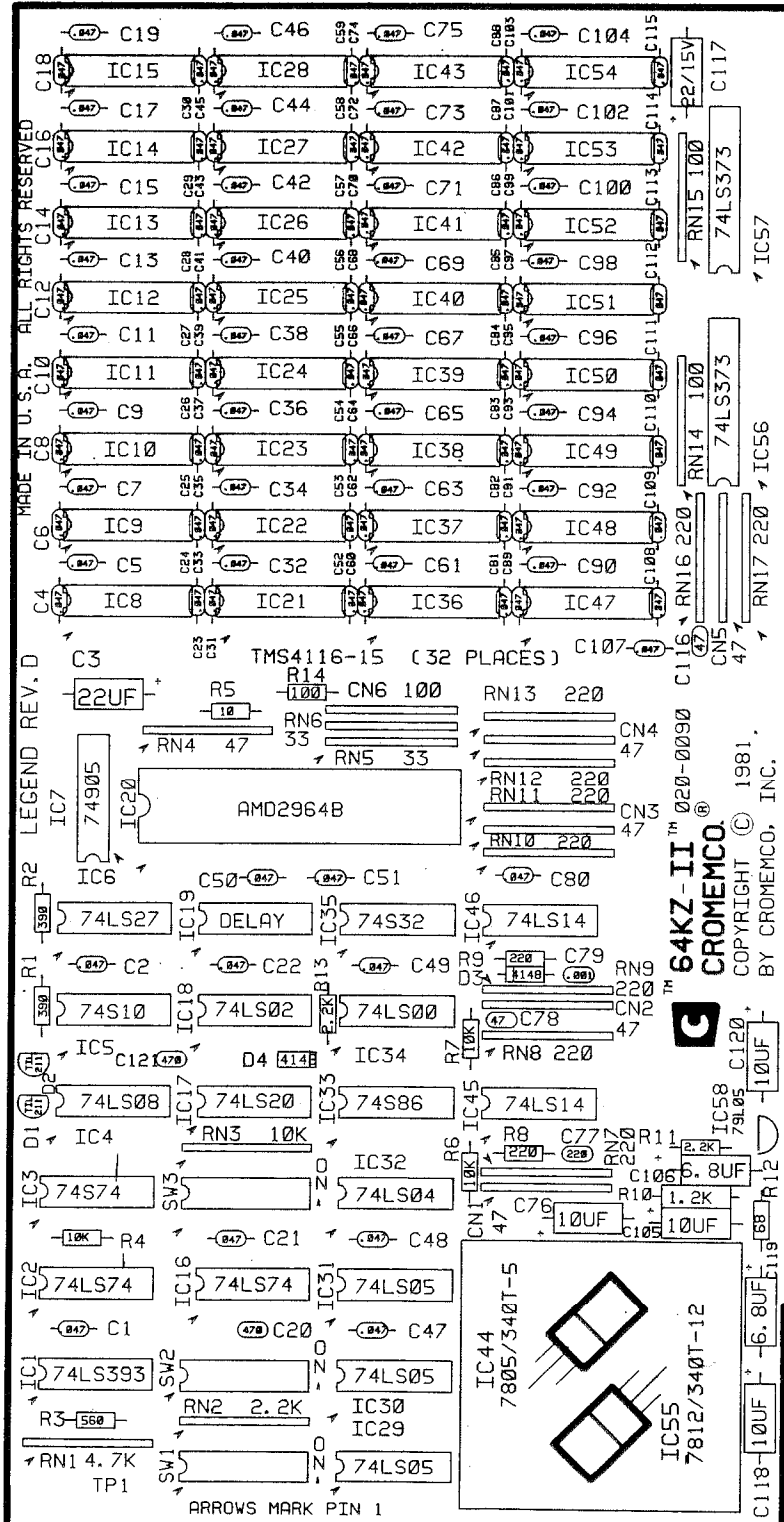

PART LOCATION DIAGRAM

64KZ-II Addendum
04-05-82

Schematic Diagram:

Replace the schematic with the new diagram included in
this addendum.